

PANTHERA PTH

Urban Lighting / Post Top Light



PTH80-R73D05Z04

Features

Classic square design post top fitting
Wide range of power and lighting distribution available
Robust high pressure die-casted aluminium construction
High performance LED light source
IP66 & IK09 rated

Applications

Urban lighting
Building surrounds
Area lighting
Parks and Pathways

Options

0-10V, PWM, Resistor
DALI
Type IV & V distribution

Standards

Manufactured under ISO 9001:2015 to standards
IEC 60598-1
IEC 60598-2-3
IEC 62722
IEC CISPR 15



PANTHERA PTH

Urban Lighting / Post Top Light



DAVISLIGHTING

Specifications

Model	PTH80-R73D05Z04
Body Colour	Grey
Nominal Power (W)	80
Input Voltage (V)	220-240
Frequency (Hz)	50/60
Luminaire Flux (lm)	8000
Luminaire Efficacy (lm/W)	100
CRI (Ra)	>70
Power Factor	>0.9
SDCM	≤5
CCT (K)	3000
Luminaire Rated Life (hr)	>50000
Operating Temp. (°C)	-35 to 50
Weight (kg)	10
IP Rating	IP66
IK Rating	IK09

Packaging Details

Model	PTH80-R73D05Z04
Product Carton Qty per box (pc)	1
Product Carton Dimension (mm)	410 x 410 x 635
Product Carton Weight (kg)	11.3
Master Carton Qty per box (pc)	1
Master Carton Dimension (mm)	410 x 410 x 635
Master Carton Weight (kg)	11.3

PANTHERA PTH

Urban Lighting / Post Top Light



DAVISLIGHTING

Lighting Data

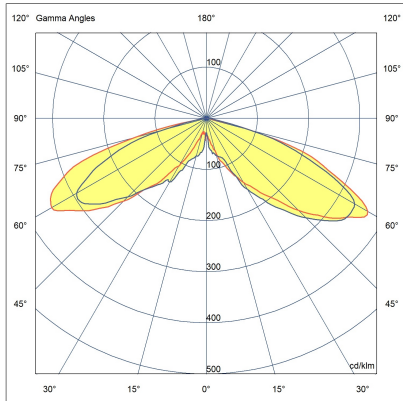

Dimensions

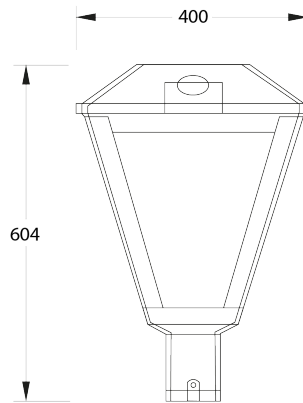

All photometric and electrical data published are of $\pm 10\%$ tolerance. Characteristics and specifications may change without notice. All electrical installations / connections should be carried out by a suitably qualified person. Application images are indicative only and may not contain actual Davis product. The information contained in this publication is typical and must not be interpreted as a guarantee of individual product performance.